

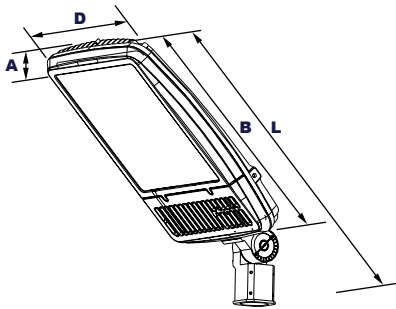

Shown with "SF" Slipfitter Mounting Option.

Dimensions



Width (D)	15 1/2" (400mm)
Length (B)	22" (559mm)
Height (A)	4" (102mm)

Length with Mount (L)

Kitty Hawk Arm (KA):	27 1/2" (699mm)
Slipfitter (SF):	29 1/4" (743mm)
Mounting Arm Adaptor (MA):	26 1/8" (664mm)
Yoke (Y):	26 1/4" (667mm)
Bracket (BR):	25 1/4" (654mm)
Wall Mount Bracket (WM):	23 1/4" (605mm)

Project Information:

Project Name:	Fixture Type:
Complete Catalog #:	Date:
Comments:	

The Incon 9044AM AmberLED Founders 45 cut-off area, wall mounted or flood light luminaire is available with a wide choice of mounting configurations and IES Type III or V distributions or a 30° narrow beam designed to replace HID lighting systems up to 400w MH or HPS for wildlife, dark skies, or security applications requiring monochromatic AMBER light. LEDs operate between 585 and 595 nm, greater than 560nm required for wildlife protection. Typical lighting applications include retail centers, industrial parks, schools and universities, public transit and airports, office buildings and medical facilities. Mounting can be accomplished using ground attachment accessories and to heights of 16 to 35 feet based on light level and uniformity requirements.

Specifications and Features:

Housing:

Die Cast Aluminum Housing and Front Frame, Integral Heat Sinking and Driver Compartment. Photocell Adaptable. Nickel-Plated Stainless Steel Hardware.

Listing & Ratings:

ETL: Listed for Wet Locations, ANSI/UL 1598, 8750; IP66 Sealed LED Compartment.

Finish:

Textured Architectural Bronze Powdercoat Finish Over a Chromate Conversion Coating. Custom Colors Available Upon Request.

Lens:

Tempered Clear Flat Glass Lens

Mounting Options:

Mounts with Kitty Hawk Arm, Adjustable Slipfitter, 2 3/8" Diameter Mounting Arm Adapter, Yoke, Two-Piece Bracket or Wall Mount Bracket. (Factory Installed)

Amber LED:

Aluminum Boards

Wattage:

Array: 167.3w, System: 180w; (250-400w HID Equivalent)

Driver:

Electronic Driver, 120-277V, 50/60Hz or 347-480V, 50/60Hz; Less Than 20% THD and PF>0.90. Standard Internal Surge Protection 6kV. 0-10V Dimming Standard for a Dimming Range of 100% to 10%; Dimming Source Current is 150 Microamps.

Controls:

Fixtures Ordered with Factory-Installed Photocell or Motion Sensor Controls are Internally Wired for Switching and/or 1-10V Dimming Within the Housing. Remote Direct Wired Interface of 1-10V Dimming is Not Implied and May Not Be Available, Please Consult Factory. Fixtures are Tested with InCon Controls and May Not Function Properly With Controls Supplied By Others. Fixtures are NOT Designed for Use with Line Voltage Dimmers.

Warranty:

5-Year Warranty for -40°C to +50°C Environment.

Certification & Listings:



Ordering Guide:

9044AM		1X167		AM	C			
Model	Beam	Wattage	Driver	CCT	Lens	Color	Mounting	Options
9044AM = AmberLED Large Founders 45 Area, Wall, and Flood Light	C =NEMA 7Hx7V F =NEMA 7Hx7V I =NEMA 4Hx4V	1X167 =167w	U =120-277V H =347-480V	AM =1400K	C =Standard Clear Flat Glass Lens	Z =Bronze C =Custom (Consult Factory)	KA =Kitty Hawk Arm SF = Slipfitter ① MA = Mounting Arm Adaptor Y =Yoke BR =Two-Piece Swivel Bracket ① WM =Wall Mount NM =No Mount	SF =Single Fuse* DF =Double Fuse* SP =Surge Protection M1 =Motion Sensor, IR for mounting heights of 20ft to 35ft M2 =Motion Sensor, IR for mounting heights of 18ft or less R3 =3-Pin Twist Lock Photocell Receptacle ① R5 =5-Pin Twist Lock Photocell Receptacle ① R7 =7-Pin ANSI C136.41—2013 Twist Lock Photocell Receptacle ① S23 =Internal Microwave Sensor with Dimming for Mounting Heights of 35' or Less.* S43 =Microwave On/Off Motion Sensor for Mounting Heights of 8' to 19'.*

Notes

① Maximum tilt angle of 45° above horizontal with R3, R5, or R7 photocell receptacle options

Order Information Example: 9044AMI1X167UAMCZSFSP

Accessories & Replacement Parts:



**Round Pole & Wall Adaptors
for KA Arm**



KH40RPZ

Die-Cast Adaptor for 4" to 6" Round Poles, Bronze Powdercoat Finish.



KH40WMZ

Die-Cast Wall Mount Adaptor, Bronze Powdercoat Finish.



PTSB1SZ



PTSB290SZ



PTSB2180SZ



PTSB390SZ*



PTSB3120SZ*



PTSB490SZ*

2 1/2" Horizontal Mounting Arms, Bronze Powdercoat Finish, Includes Hardware. Mounts to 2 3/8" Vertical Pole Top Tenons. *Non-stock item. Consult factory for lead time

**Accessories
(Order Separately, Field Installed)**

P18131	Twist Lock Non-Shorting (Open) Cap Disconnects Service to Fixture for Temporary or Permanent Disabling (Fixture Always Off). IP65, 480V Maximum.
P18132	Twist Lock Shorting Cap Provides Fixed Service to Fixture (Fixture Always on). IP65, Rated Load 7200w Tungsten.
P18140	110-120VAC Instant Twist Lock Photocell
P18152	277VAC Time Delay Twist Lock Photocell
P18156	120-277VAC Universal Twist Lock Photocell
P18157	480VAC Time Delay Twist Lock Photocell. For 480V use only.
ACCCHSG1Z	Die Cast Accessory Housing for Installing Sensors or Other Lighting Controls, Bronze Powdercoat Finish
KH45GSZ	Aluminum Glare/House Side Shield, Bronze Powdercoat Finish, Includes Hardware.
KH45WG	Wire Guard, Stainless Steel Construction, Includes Hardware.
ACCCHSG3	Bronze UV-Stabilized Polycarbonate Housing for Installing Sensors, Includes Sensor Bracket and Gasket.



ACCCHSG1Z



KH45GSZ



KH45WG



ACCCHSG3

**Replacement Parts
(Order Separately, Field Installed)**

KH45AZ	Kitty Hawk Mounting Arm, Mounts Directly to Square Poles, Bronze Powdercoat Finish
FL73SFZX	External Mount Slipfitter, Die Cast, Bronze Powdercoat Finish
ALMAAZ	Pole Mounting Arm Adaptor, Fits 2 3/8" Arm, Includes Hardware, Bronze Powdercoat Finish
KH45YZ	Yoke, Stamped Heavy-Duty Steel, Bronze Powdercoat Finish
FL73BRZ	Two-Piece Swivel Bracket, Stamped Steel, Bronze Powdercoat Finish
WBR2Z	Wall Bracket, Heavy-Duty Stamped Steel, Bronze Powdercoat Finish, Includes Hardware.
P17117	Internal Microwave Sensor with Dimming, 120-277VAC, 50/60Hz. See AIP17117 Specification Page for Details.
P17123	Internally Mounted Microwave On/Off Motion Sensor for Mounting Heights of 8' to 19', 120-277VAC, 50/60Hz



P17117



P17123

Mounting Options:



9044AM with Kitty Hawk Arm (KA)

Kitty Hawk Die-Cast Mounting Arm, Bronze Powdercoat Finish, Includes Hardware. Mounts Directly to Square Poles.



9044AM with Pole Mounting Arm Adaptor (MA)

Die-Cast Adaptor for 2 3/4" Horizontal Mounting Arms, Bronze Powdercoat Finish, Includes Hardware.



9044AM with Yoke (Y)

Stamped Heavy-Duty Steel Yoke, Bronze Powdercoat Finish, Includes Hardware.



9044AM with "SF" External Mount Slipfitter (SF)

External Mount Die-Cast Adjustable Slipfitter for 2 3/4" Tenons, Bronze Powdercoat Finish, Includes Hardware.



9044AM with Two-Piece Swivel Bracket (BR)

Two-Piece Stamped Steel Adjustable Bracket, Bronze Powdercoat Finish, Includes Hardware.



9044AM with Wall Mount (WM)







Wall Bracket, Heavy-Duty Stamped Steel, Bronze Powdercoat Finish, Includes Hardware.

Notes

① Maximum tilt angle of 45° above horizontal with R3, R5, or R7 photocell receptacle options

EPA (Effective Projected Area)

Shown with Large Kitty Hawk Arm mounting.

Configuration	EPA (Sq. Ft.)	Weight (Lbs.)	Configuration	EPA (Sq. Ft.)	Weight (Lbs.)	Configuration	EPA (Sq. Ft.)	Weight (Lbs.)	Configuration	EPA (Sq. Ft.)	Weight (Lbs.)
 1	1.00	33 Lbs	 2@180° Mount	2.00	66 Lbs	 3@90° Mount	2.20	99 Lbs	 4@90° Mount	2.20	132 Lbs
			 2@90° Mount	1.36	66 Lbs	 3@120° Mount	2.00	99 Lbs			

Photometric Data

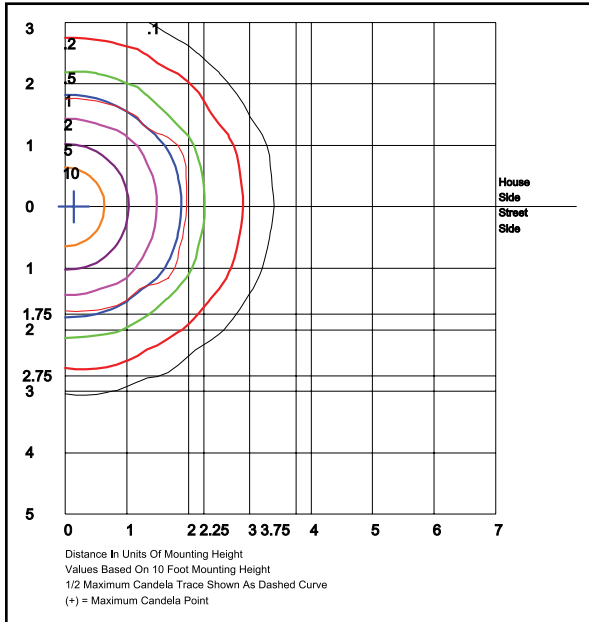

9044AMF1X167UAMC-
Type V
Grid in MH
MH=10 Feet

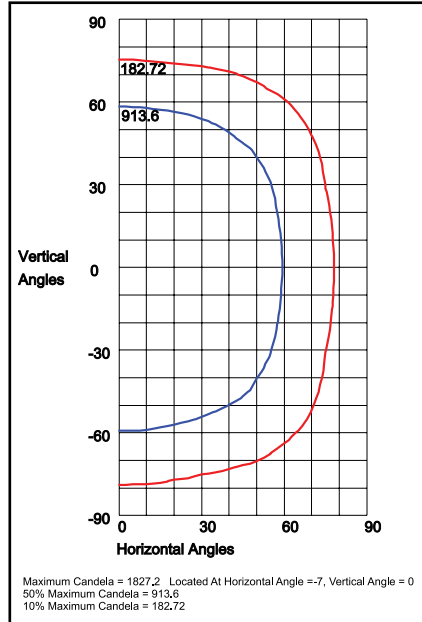

9044AMF1X167UAMC
115H x 110V, NEMA 7H x 7V

Spectral Chart

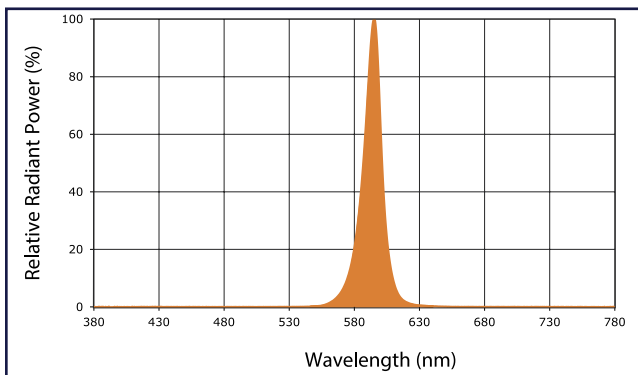

Photometric Performance

LED Board Watts	Drive Current (mA)	Input Watts	Optics	Amber LEDs				
				Lumens	LPW	B	U	G
AmberLED 167w	525	180	F Type V	5,717	32	2	2	1

LED Board Watts	Drive Current (mA)	Input Watts	Beam	Amber LEDs	
				Lumens	LPW
AmberLED 167w	525	180	F 115H x 110V, NEMA 7H x 7V	5,673	32